

Številka modela:
2312-531-84

Tip
531

ESENA

2D1W

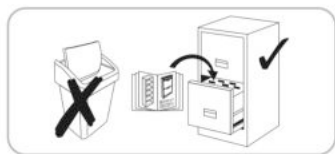
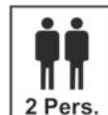
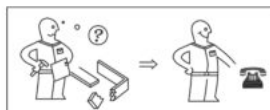
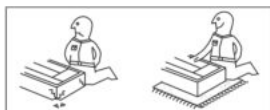
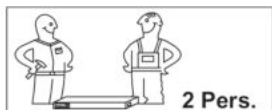



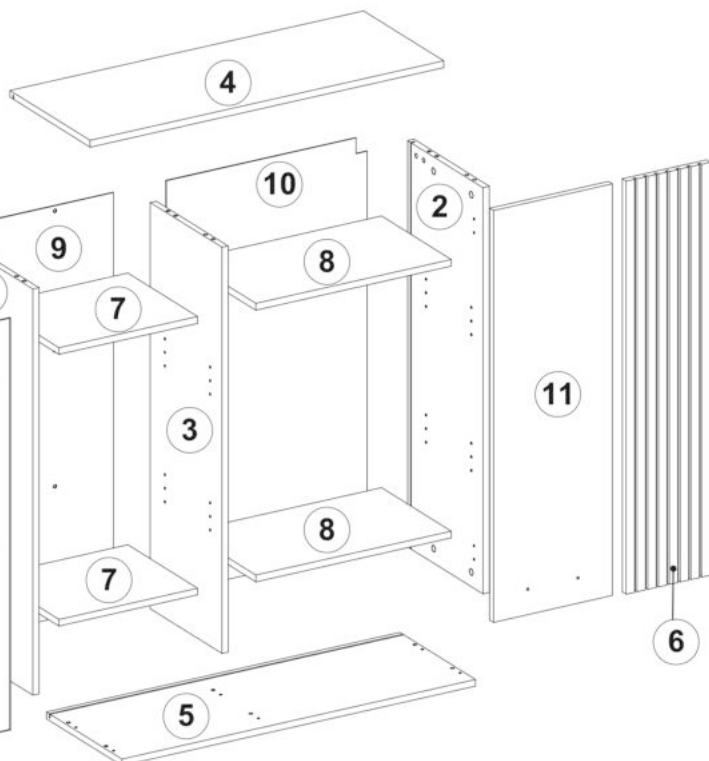
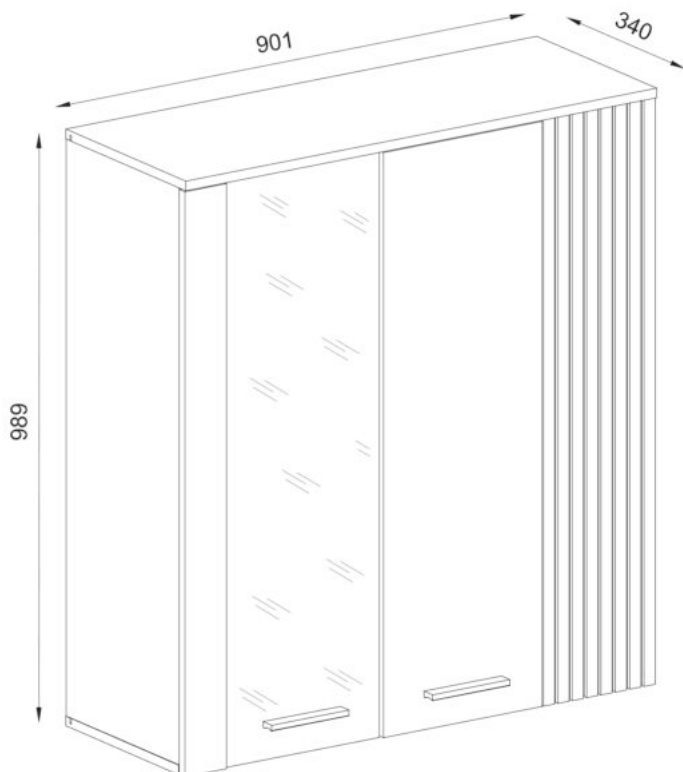



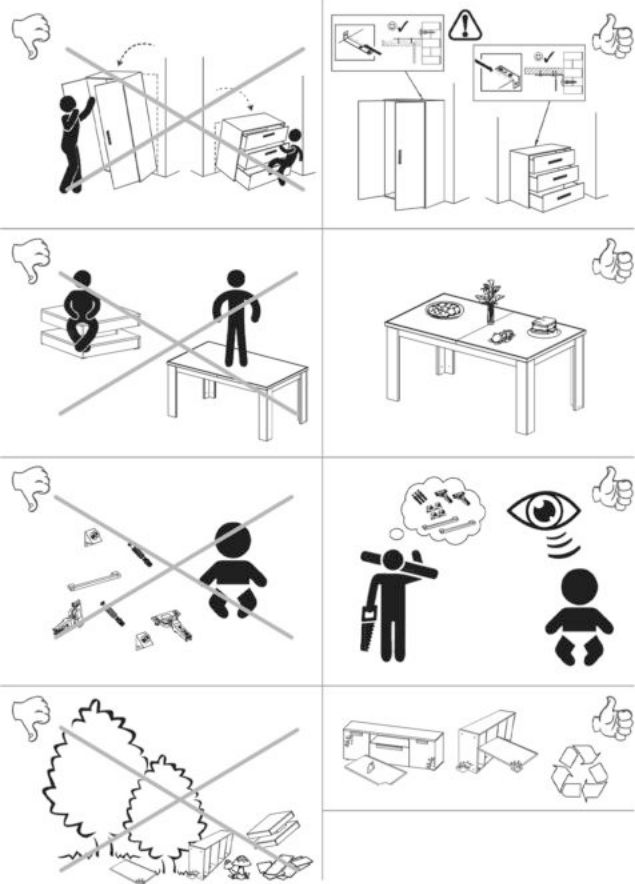











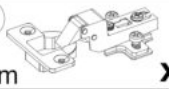

ø10mm



A	B (mm)		C	D
1	957	320	16	x1 2/2
2	957	320	16	x1 2/2
3	957	304	16	x1 2/2
4	901	340	16	x1 2/2
5	901	320	16	x1 1/2
6	970	214	16	x1 1/2
7	353	295	16	x2 2/2
8	498	295	16	x2 2/2
9	972	369	2,5	x1 1/2
10	972	512	2,5	x1 1/2
11	970	303	16	x1 1/2
12	970	376	16	x1 1/2
B1				1/2



B1 **1/2**

A1 15x12  x12	C2 44mm  x12	O1 ø18mm  x12
Y40 55mm  x2	D11 3,5x16  x12	D10 3x16  x4
B2 8x30  x12	N5 10x6x10  x2	K6 ø35mm  x4
K7 ø35mm  x2	J65 128/148  x2	R5 ø6mm  x4
DA21 4,2x16  x2	M1 10x10x15  x16	S4 20x10x2mm  x4
N1 ø6mm  x16	DB2 4x25  x2	D26 4x30  x4
Y2/R  x1	Y2/L  x1	Y39 10x50  x2

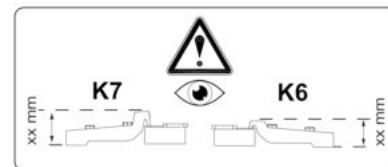

Spoštovana stranka, zahvaljujemo se vam za nakup pohištva iz našega notranjega programa za izključno uporabo v zasebnih prostorih. Prosimo, da preverite popolnost obsega dobave in pred namestitvijo natančno preberete naslednje pomembne informacije ter jih shranite za poznejšo uporabo, tudi s strani tretjih oseb. Naše pohištvo je treba uporabljati v skladu s predpisi. Uporaba v nasprotju s predpisi lahko povzroči materialno škodo in v določenih okoliščinah tudi telesne poškodbe. Pohištvo ni igrača. Proizvajalec ali prodajalec ne prevzemata jamstva za škodo, ki nastane zaradi uporabe v nasprotju s predpisi ali nepravilnega ravnanja.

OPOZORILO: Otroci ali osebe z motnjami v duševnem razvoju se morajo ves čas izogibati delom pohištva, koničastim predmetom, majhnim delom in embalaži, saj obstaja nevarnost poškodb in/ali zadužitve.

MONTAŽA: Pri sestavljanju upoštevajte naša navodila za uporabo, delovanje, namestitvev ali montažo ter bodite posebej pozorni na opozorila in varnostna navodila. Neupoštevanje navodil lahko povzroči telesne poškodbe ali poškodbe pohištva/varnostne nevarnosti. Če imate kakršne koli težave pri namestitvi/montaži, se obrnite na našo servisno službo. Z veseljem vam bodo svetovali in pomagali. Namestitev lahko opravi le usposobljeno osebe. Ne prevzemamo nobene odgovornosti za škodo, če so na izdelku/delu/delah izdelka opravljene spremembe ali če so zamenjani ali uporabljeni deli/potrošni material, ki ne izvirajo od proizvajalca/prodajalca. Če so z blagom dobavljeni stenski pritrdilni elementi, kot so zatiči in vijaki, so ti namenjeni samo za uporabo na stenah iz trdnih in homogenih materialov. Pritrditev je tako dobra kot povezava med pritrditvijo in steno. Pred pritrditvijo morate preveriti primernost stene za stoječe in viseče pohištvo ter uporabiti le primerne pritrdilne elemente. Pred vsakim nameščanjem se prepričajte, da v prostoru za dobrodošlico ni električnih žic. Na koncu je za pritrditev stene odgovoren monter.





To velja tudi za vgradnjo električnih izdelkov in drugih gradbeno-tehničnih pripomočkov. Montažo/vgradnjo električnih izdelkov in drugih pomembnih gradbeno-tehničnih pripomočkov lahko izvaja le pooblaščen usposobljeno osebe. Vse električne in gradbeno-tehnične inštalacije morajo biti izvedene v skladu z veljavnimi standardi in varnostnimi predpisi v vaši državi. Pri svetlobnih virih uporabljajte le dovoljeno jakost osvetlitve. Neupoštevanje največjega števila vatov lahko povzroči nevarnost požara zaradi pregrevanja. Zaradi nevarnosti požara prekrivanje svetilk ni dovoljeno. Popolno delovanje pohištva je zagotovljeno le pri navpični in vodoravni namestitvi. Vrata so vnaprej nastavljena, vendar jih je mogoče glede na lokalne razmere ponovno nastaviti. Upoštevajte podatke o teži za največjo obremenitev. Na pohištvo se ne sme plezati. Ob nestrokovni uporabi se lahko pohištvo prevrne. Da bi to preprečili, je treba pohištvo vedno zavarovati pred prevrnitvijo. Pri preobremenitvi/preveliki obremenitvi (zlasti zaradi igranja otrok, ljudi, materialov ali drugih neprimeren vplivov) obstaja nevarnost zloma in poškodb. Vse vijake in podporne priključne točke je treba po 5 do 6 tednih zategniti, da se zagotovi trajna stabilnost.

SKRB ZA POHIŠTVO—Da bi v našem izdelku uživali čim dlje, upoštevajte naša navodila za pravilno nego pohištva. Pri čiščenju uporabljajte čisto, suho in mehko bombažno krpo. Če pohištvo potrebuje temeljito čiščenje, lahko krpo navlažite z malo vode ali čistilom za pohištvo in nato očiščene dele posušite. Kovinske in steklene dele je najbolje očistiti s komercialno dostopnimi čistili za kovine in steklo v skladu z navodili na izdelku. Na čistilih mora biti jasno navedeno, da so primerna za čiščenje pohištva. Nikakor ne uporabljajte parnih čistil, kavstičnih sredstev, abrazivnih sredstev ali drugih izdelkov, katerih učinkov ne poznate. **POZOR:** Površine z visokim sijajem so ob dobavi zaščitene z zaščitno folijo. Folijo pustite na pohištvi, dokler ni popolnoma sestavljeno in očiščeno prahu. Predmete z visokim sijajem, s katerih je bila odstranjena zaščitna folija, lahko očistite in uporabite šele po 72 urah (čas za naknadno strjevanje na zunanjem zraku). Površin ne smete poškodovati z ostrimi predmeti in jih nikoli ne smete izpostavljati močni sončni svetlobi.

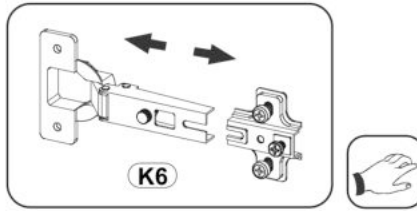
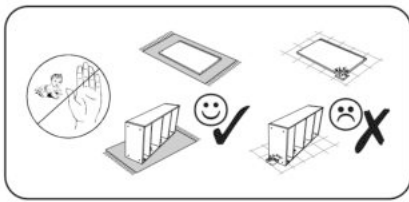
LIKVIDACIJA— Navodila za odstranjevanje odpadkov —

Za zaščito okolja odpadno embalažo odlagajte ločeno po vrstah v za to namenjene smetnjake/koše za recikliranje in je v nobenem primeru ne odlagajte v okolje. Poškodovano ali neuporabno pohištvo lahko pošljete v posebne zbirne centre za recikliranje posameznih delov. Rabljenega, a še vedno funkcionalnega pohištva ni treba takoj odstraniti. Podarite ga na primer dobrodelnim organizacijam. Želimo vam veliko veselja z novim pohištvom.

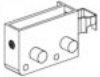
1

B2		x8
8x30		
A1		x8
15x12		
K6		x4
ø35mm		
Y2/R		x1
Y2/L		x1
D26		x4
4x30		

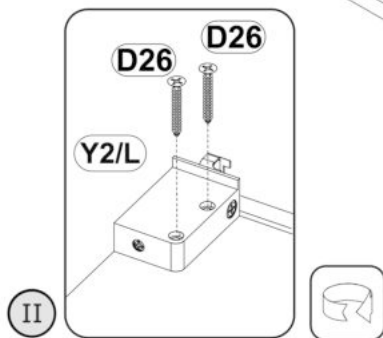
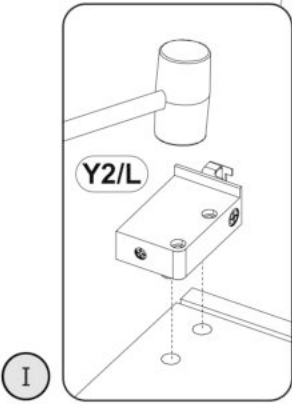
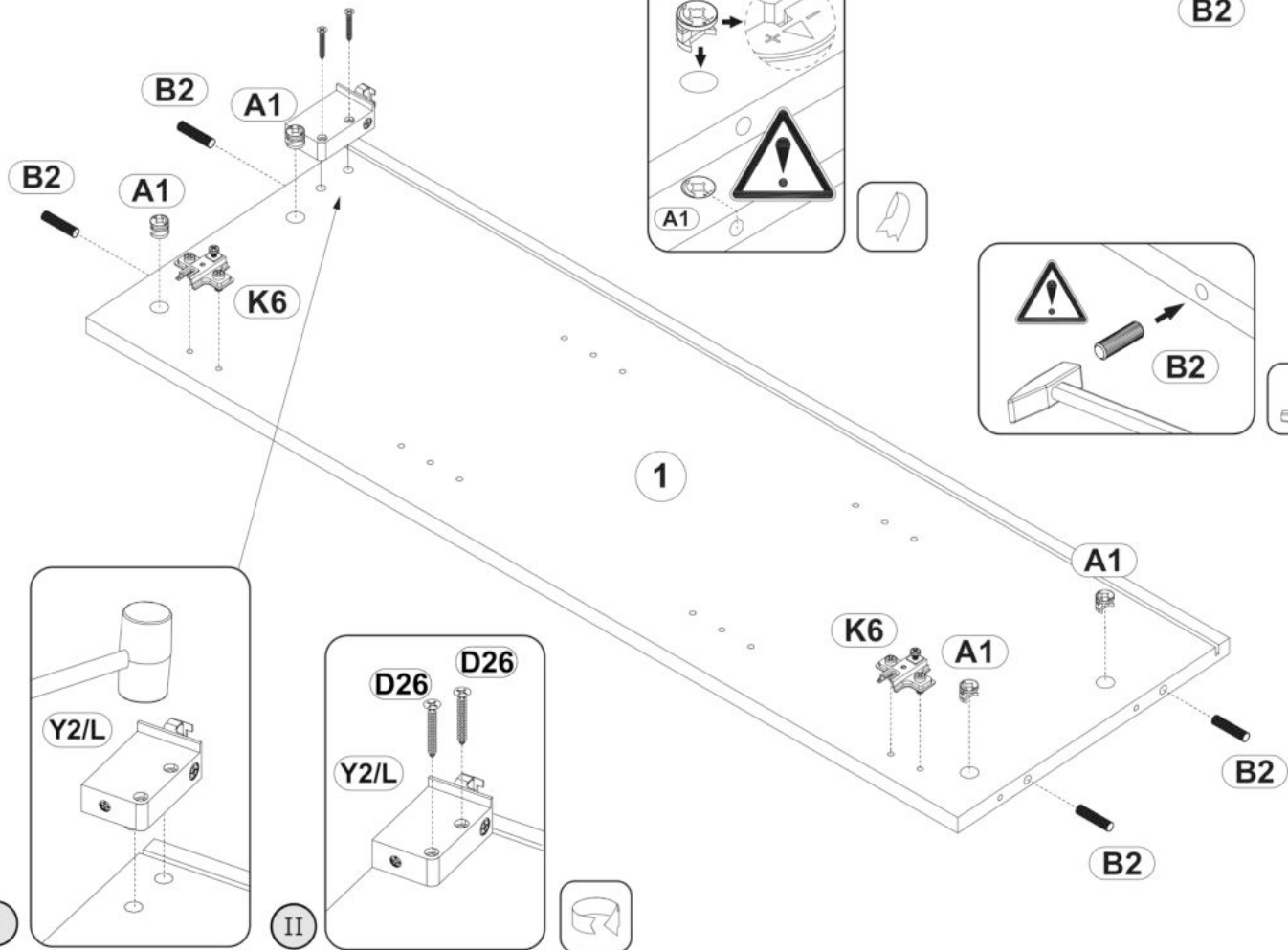
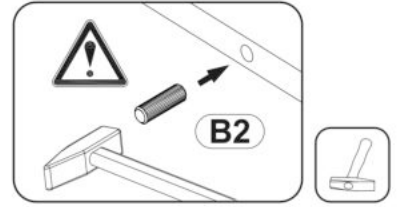
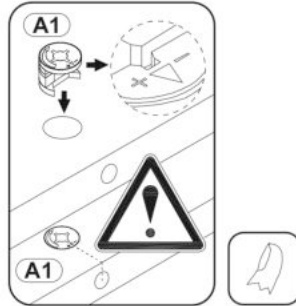
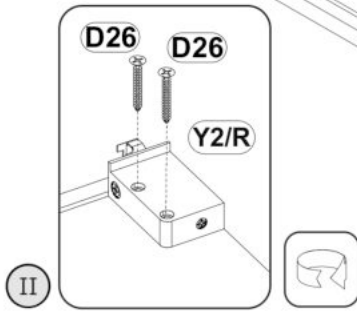
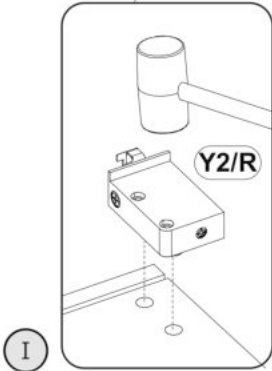
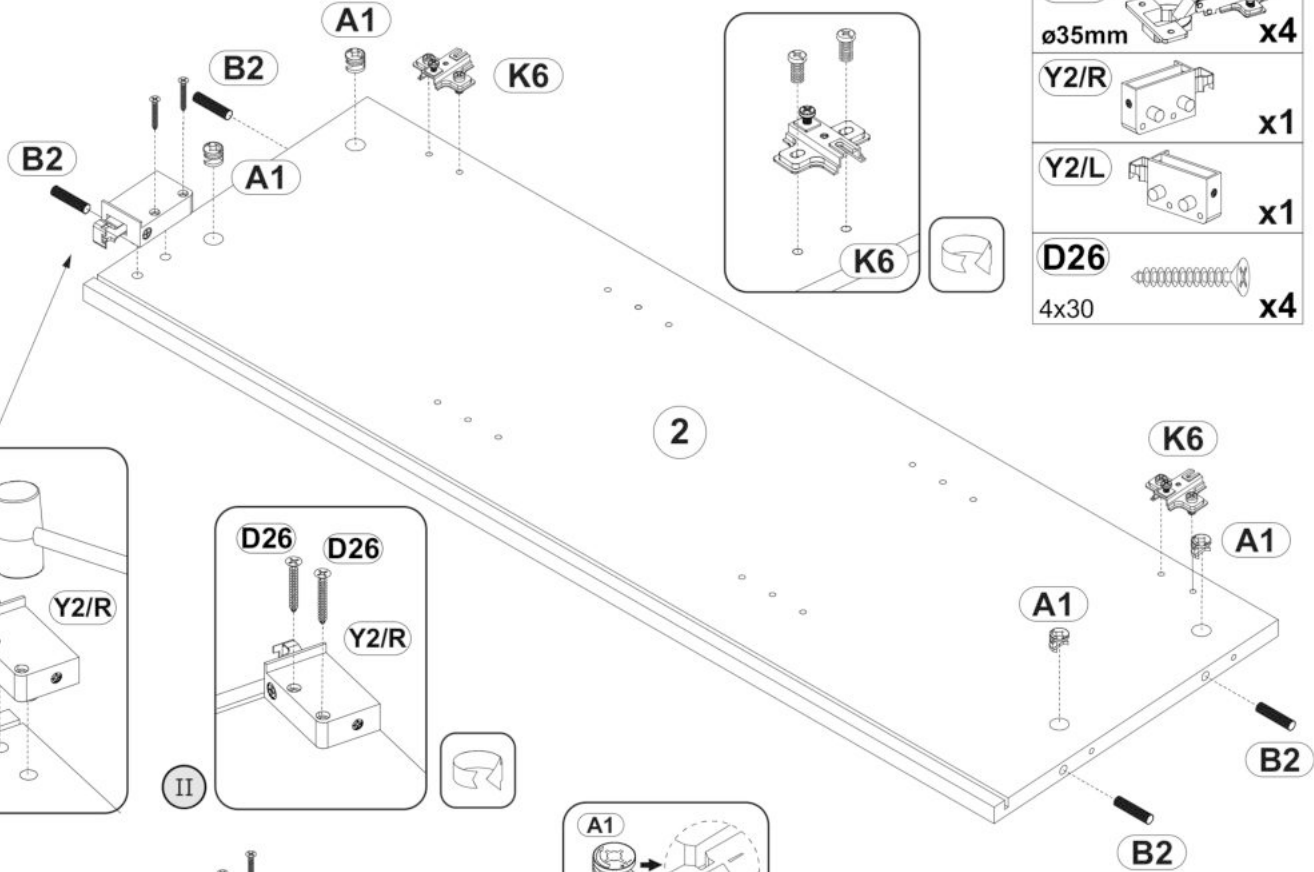

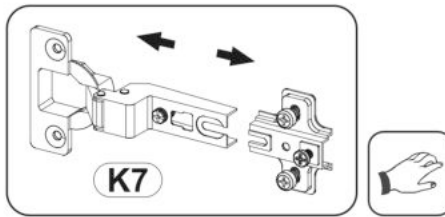
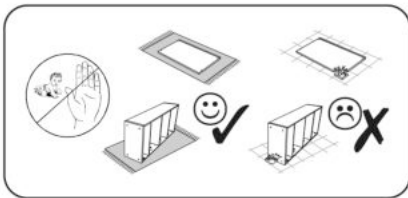

B2		x4
A1		x4
C2		x12
K7		x2

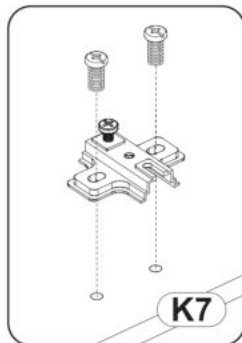
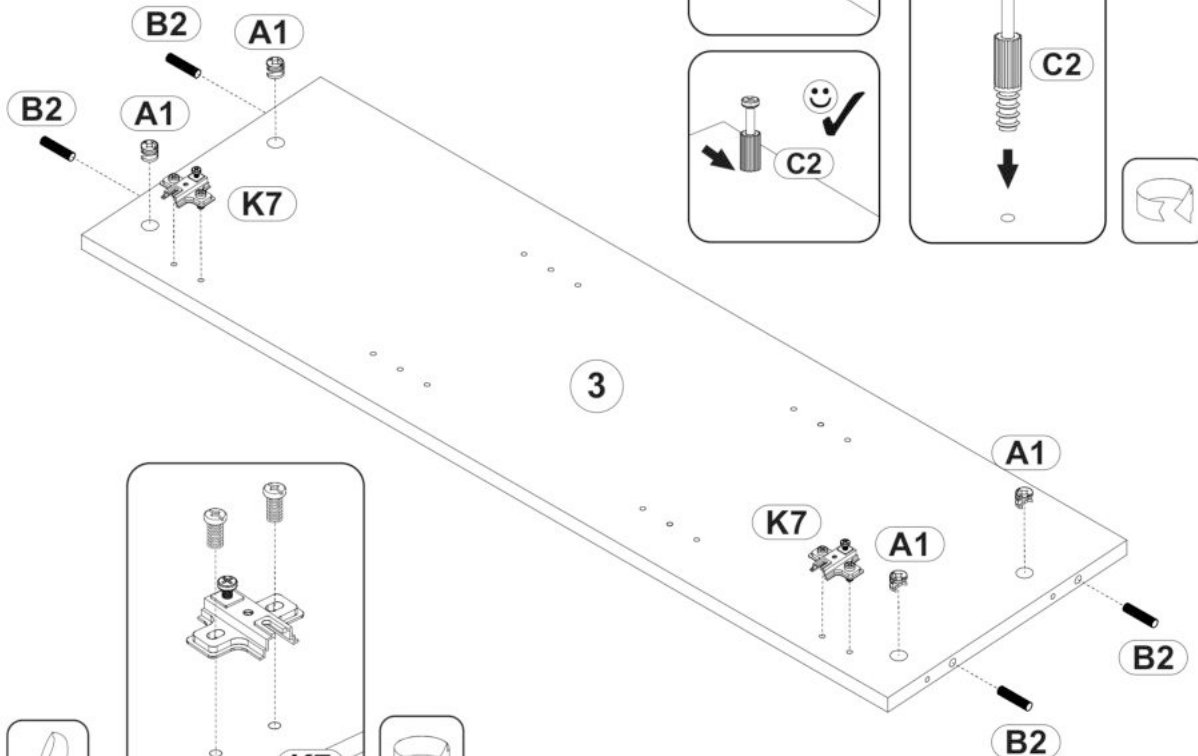
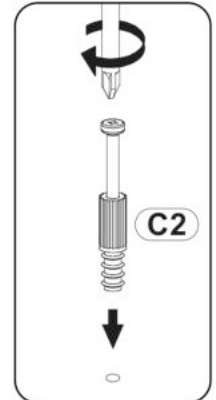
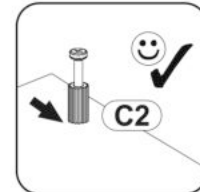
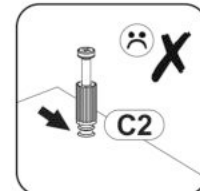
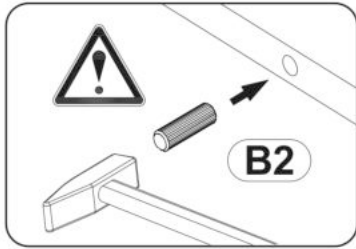
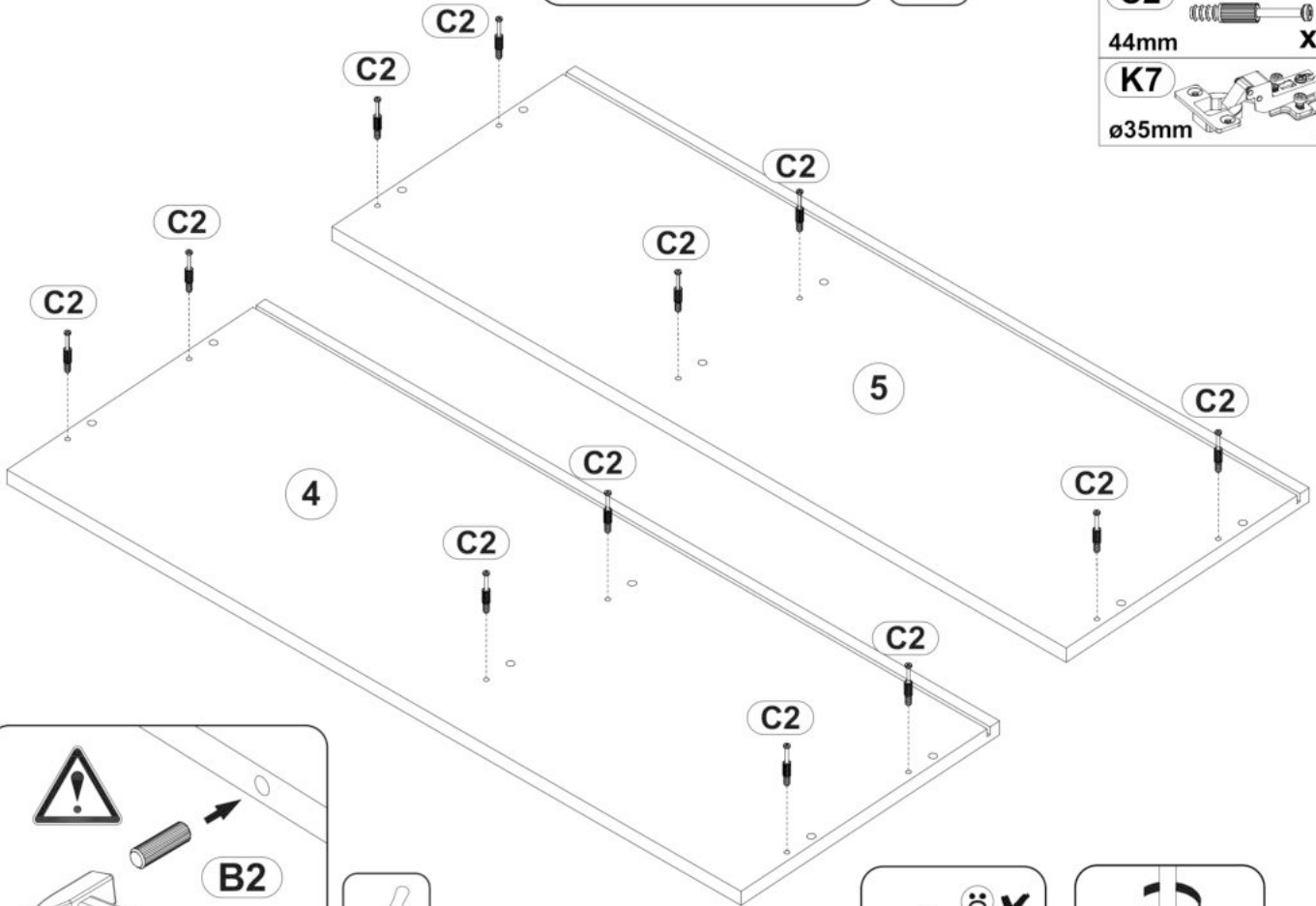

3

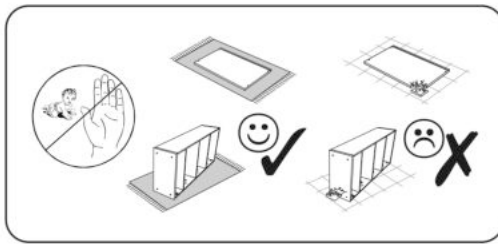

O1
ø18mm x6

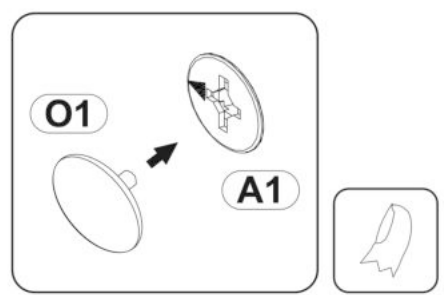
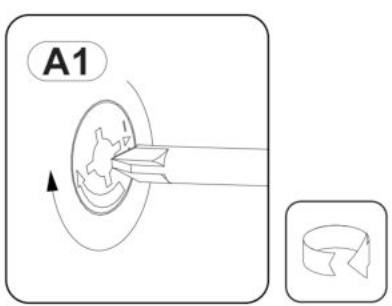
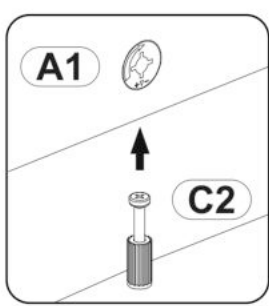
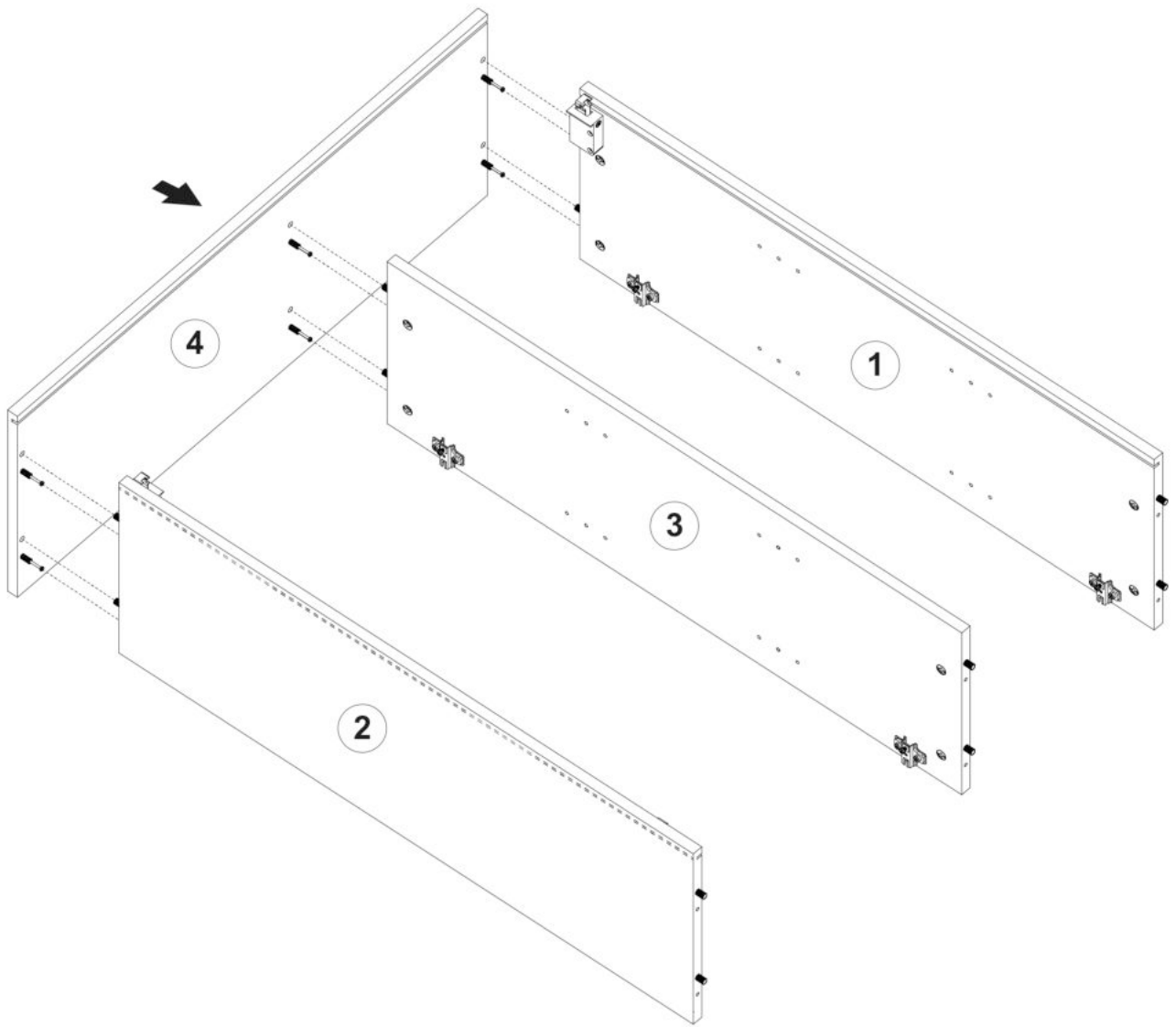

4

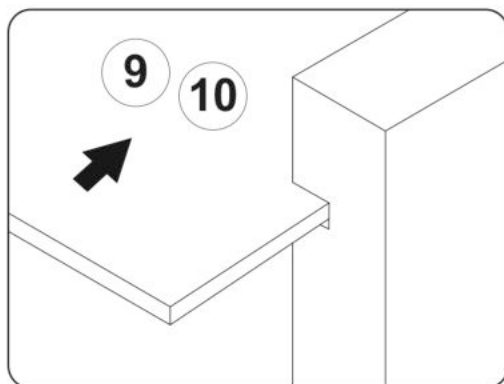
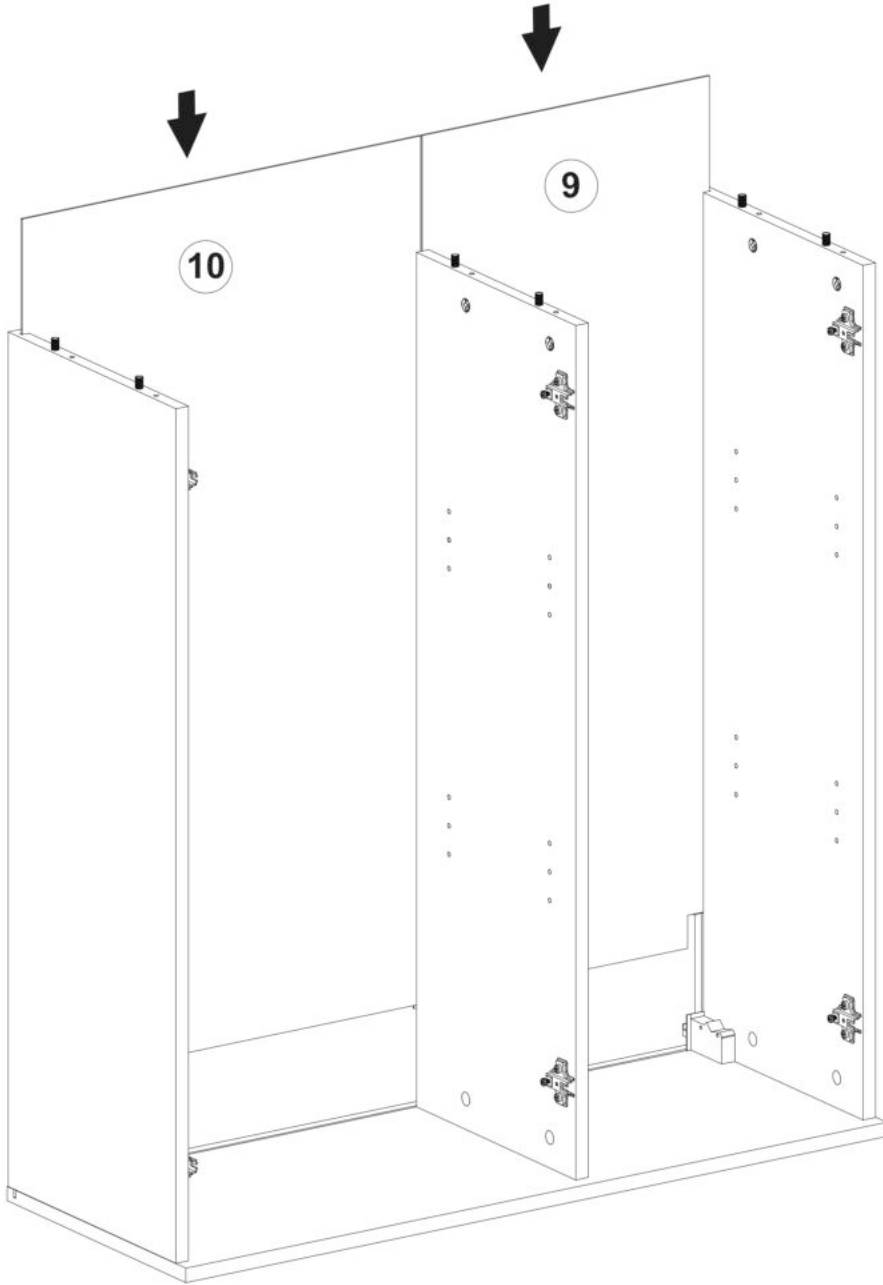

5

O1
ø18mm x6

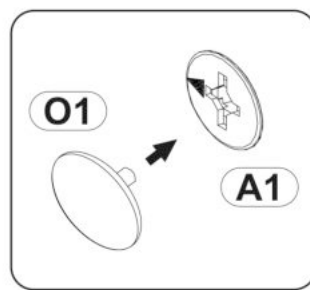
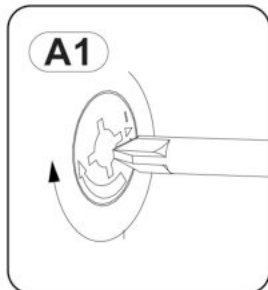
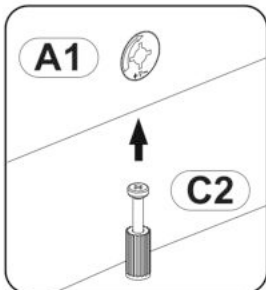
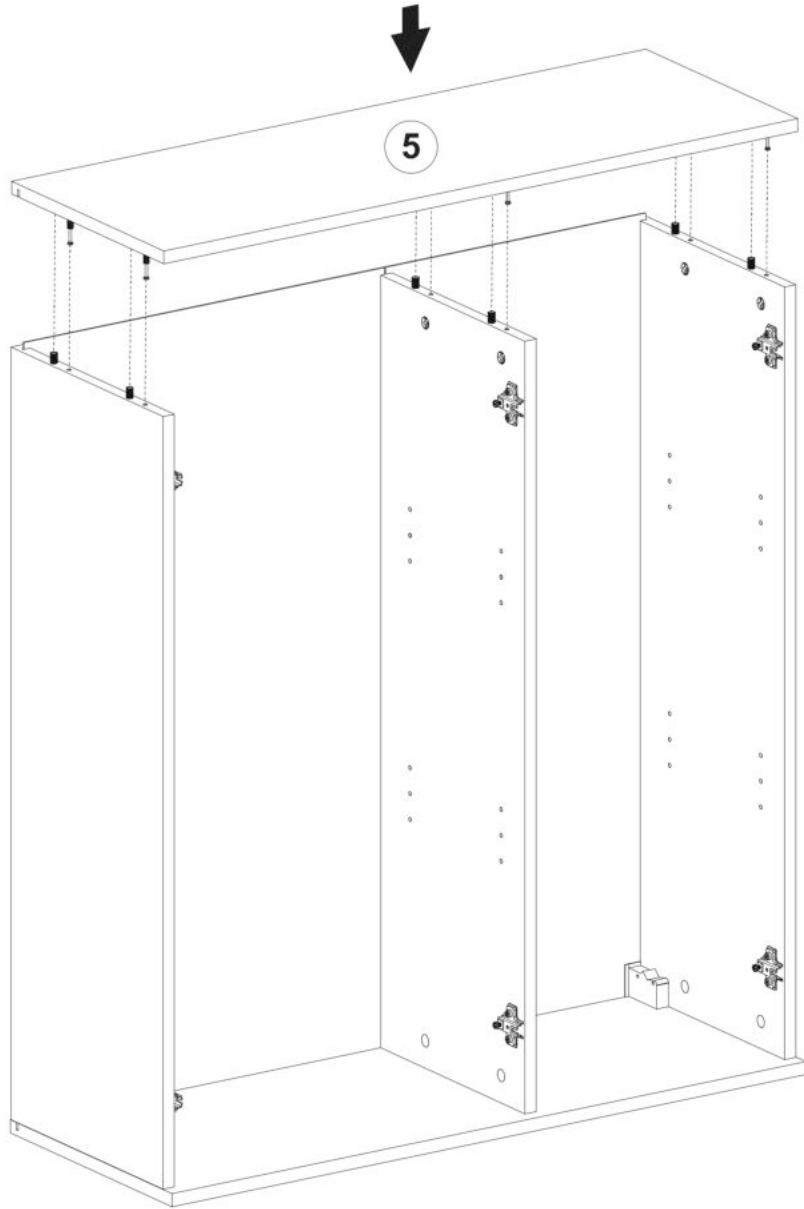

6

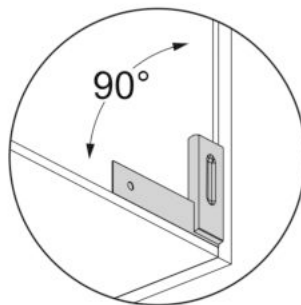
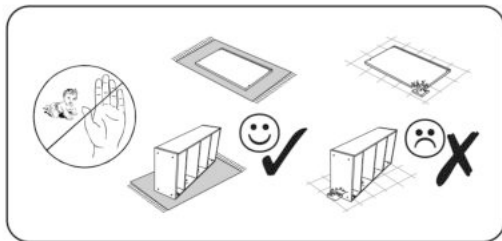

M1		x16
10x10x15		
S4		x4
20x10x2mm		
D10		x4
3x16		

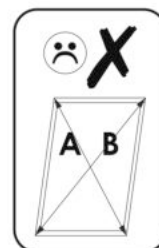
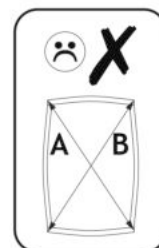
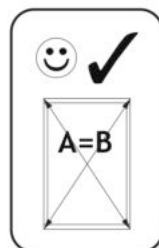
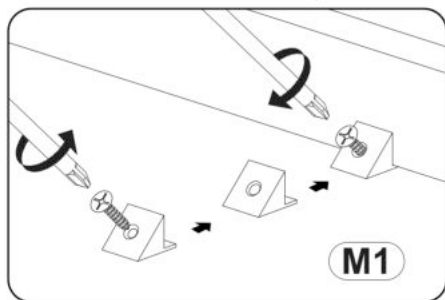
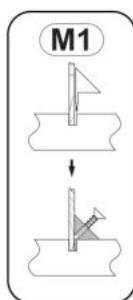
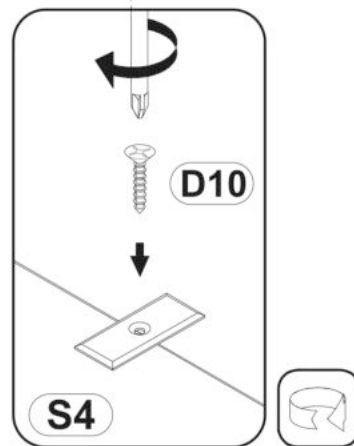
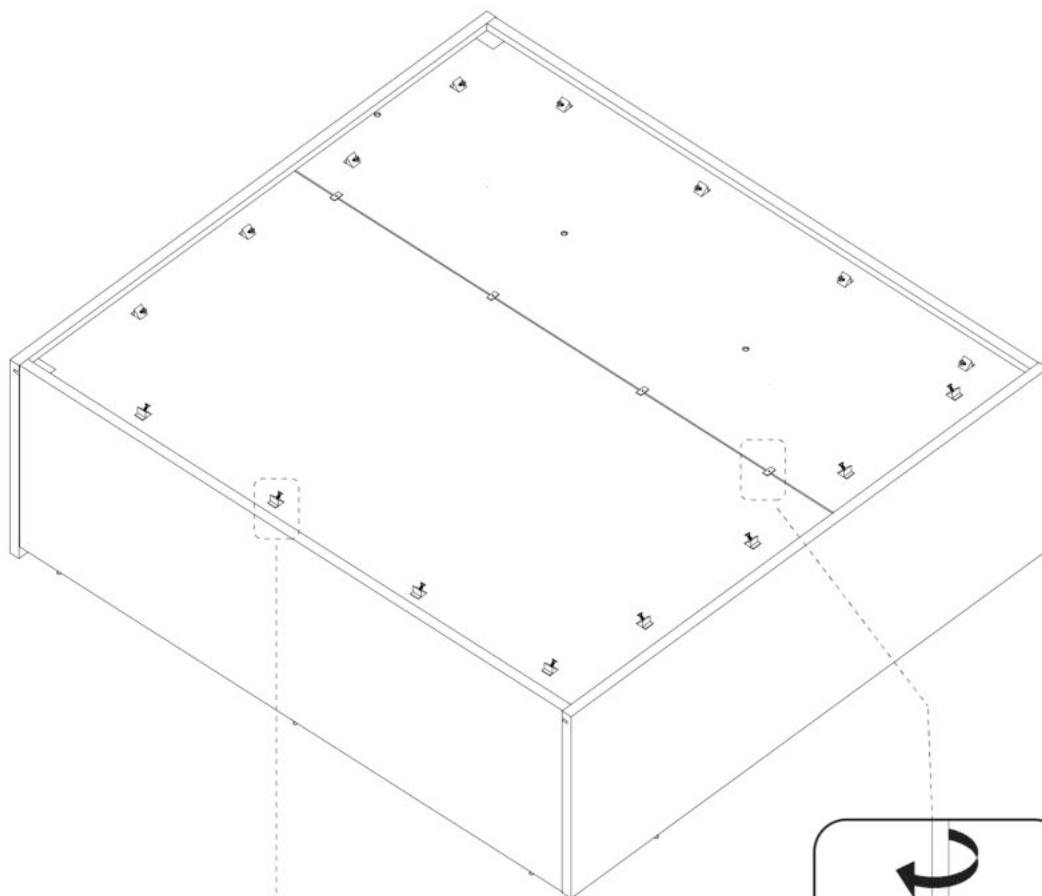

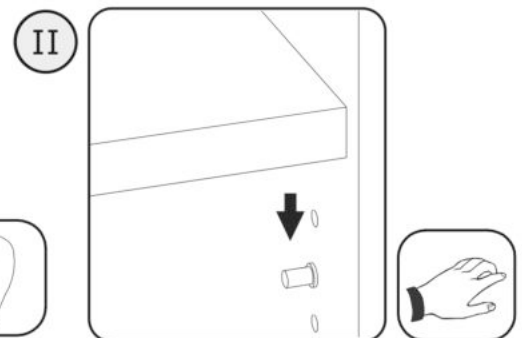
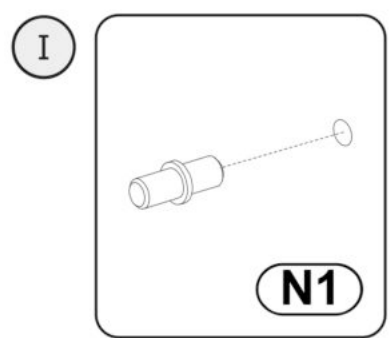
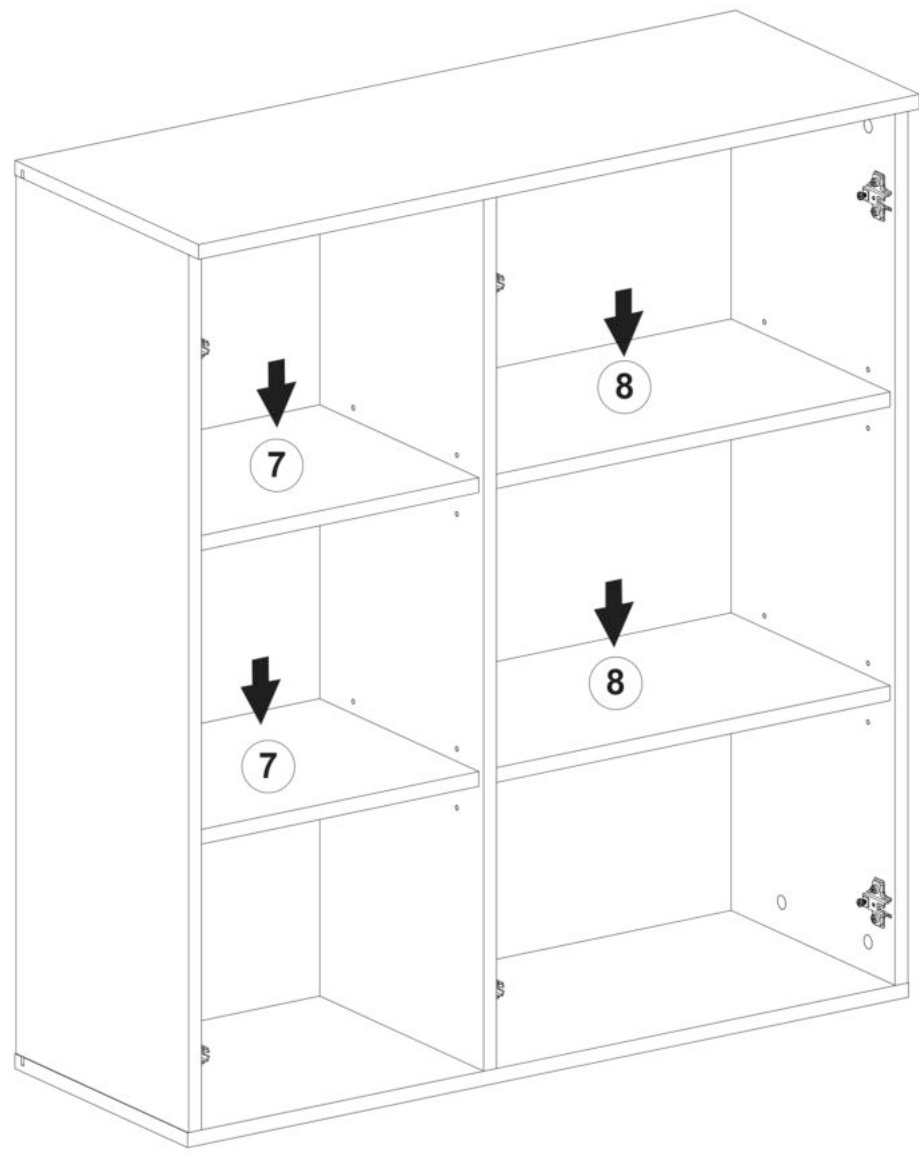

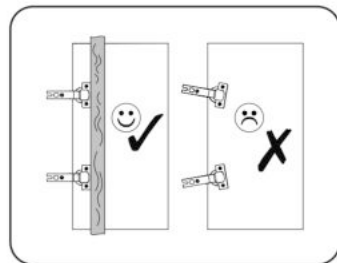
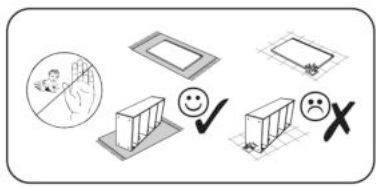

K6		x4
$\varnothing 35\text{mm}$		
D11		x8
3,5x16		
J65		x1
128/148		
DA21		x2
4,2x16		
R5		x3
$\varnothing 6\text{mm}$		
N5		x2
10x6x10		

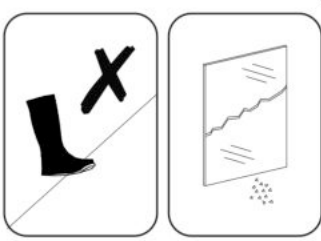
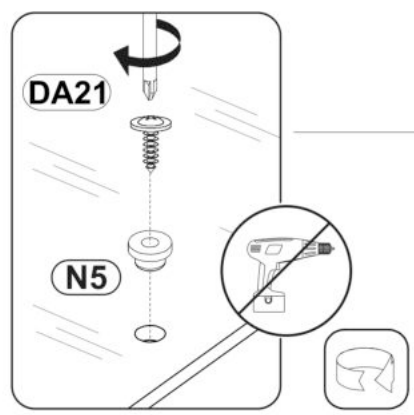
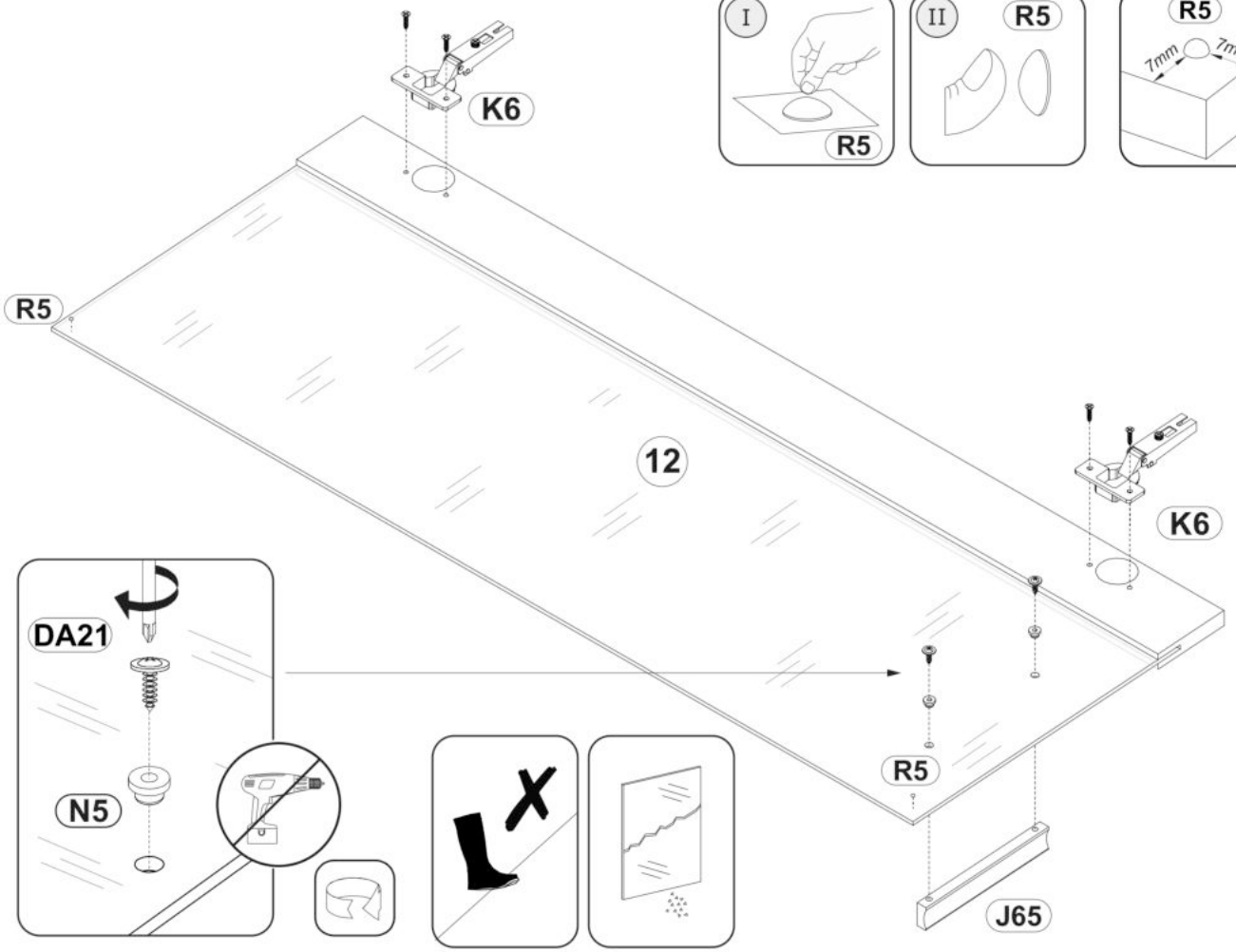
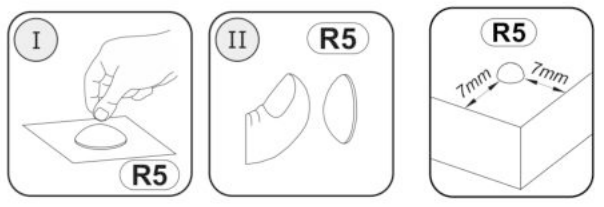
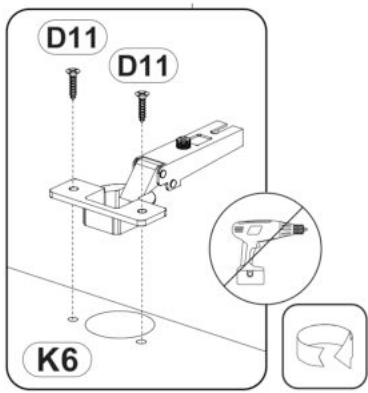
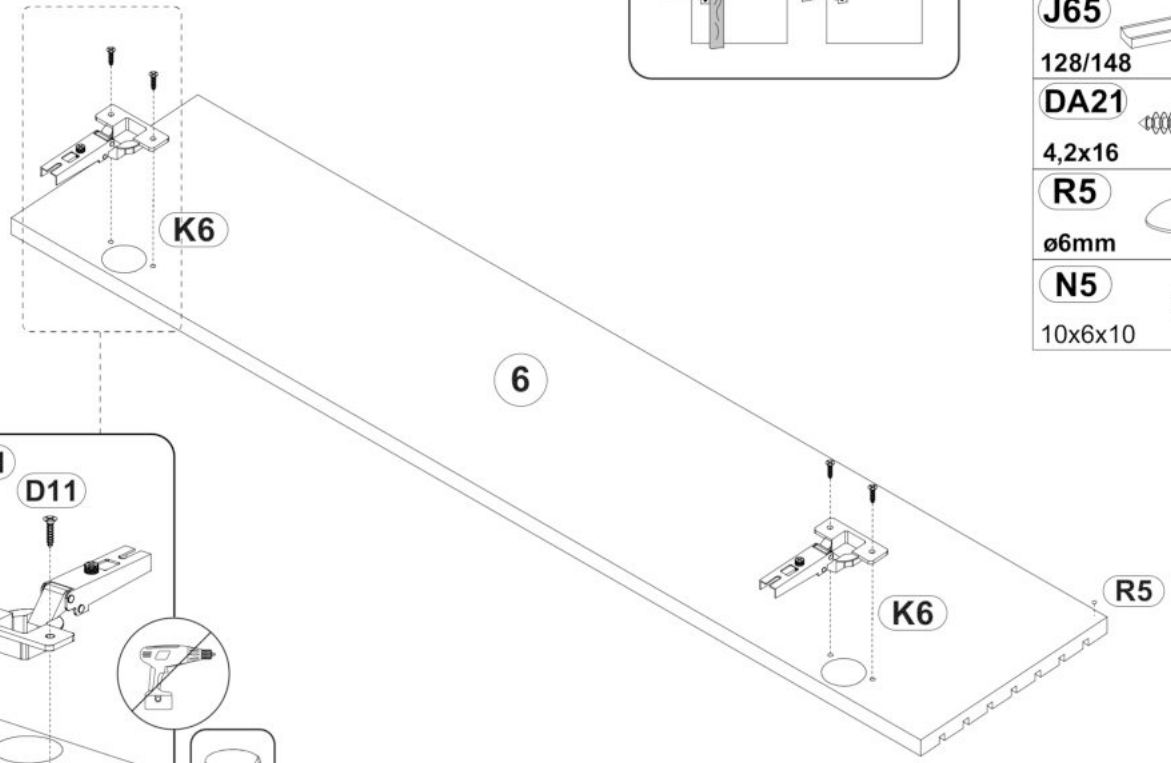

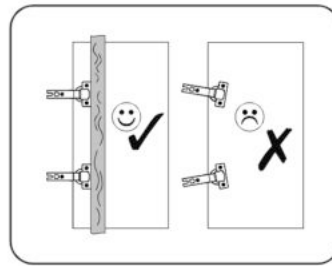
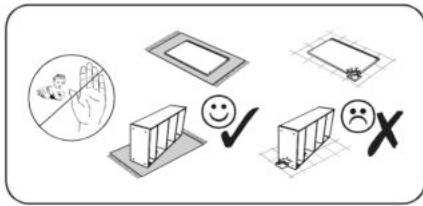

K7		x2
DB2		x2
D11		x4
J65		x1
R5		x1

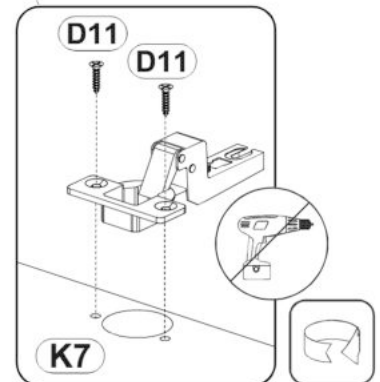
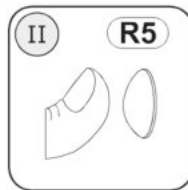
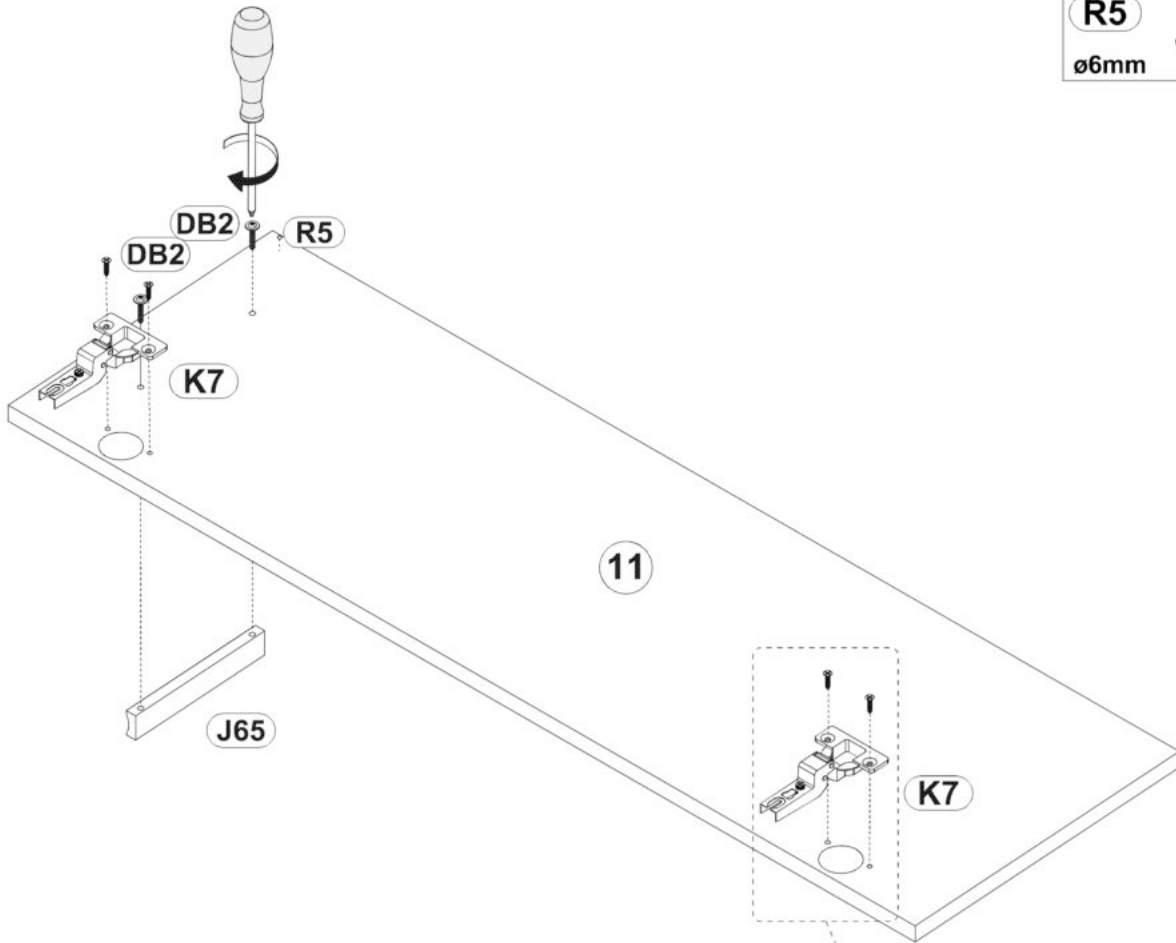

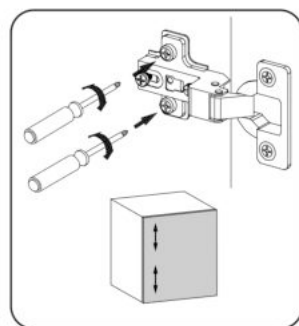
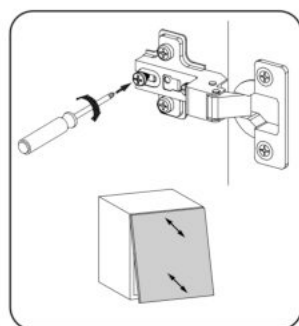
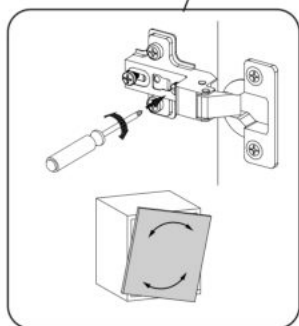
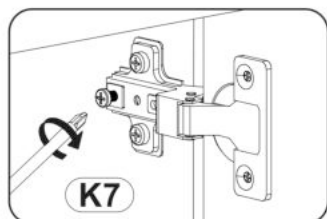
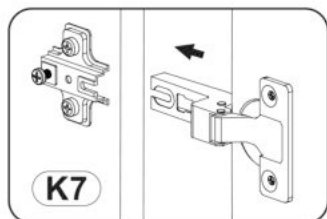
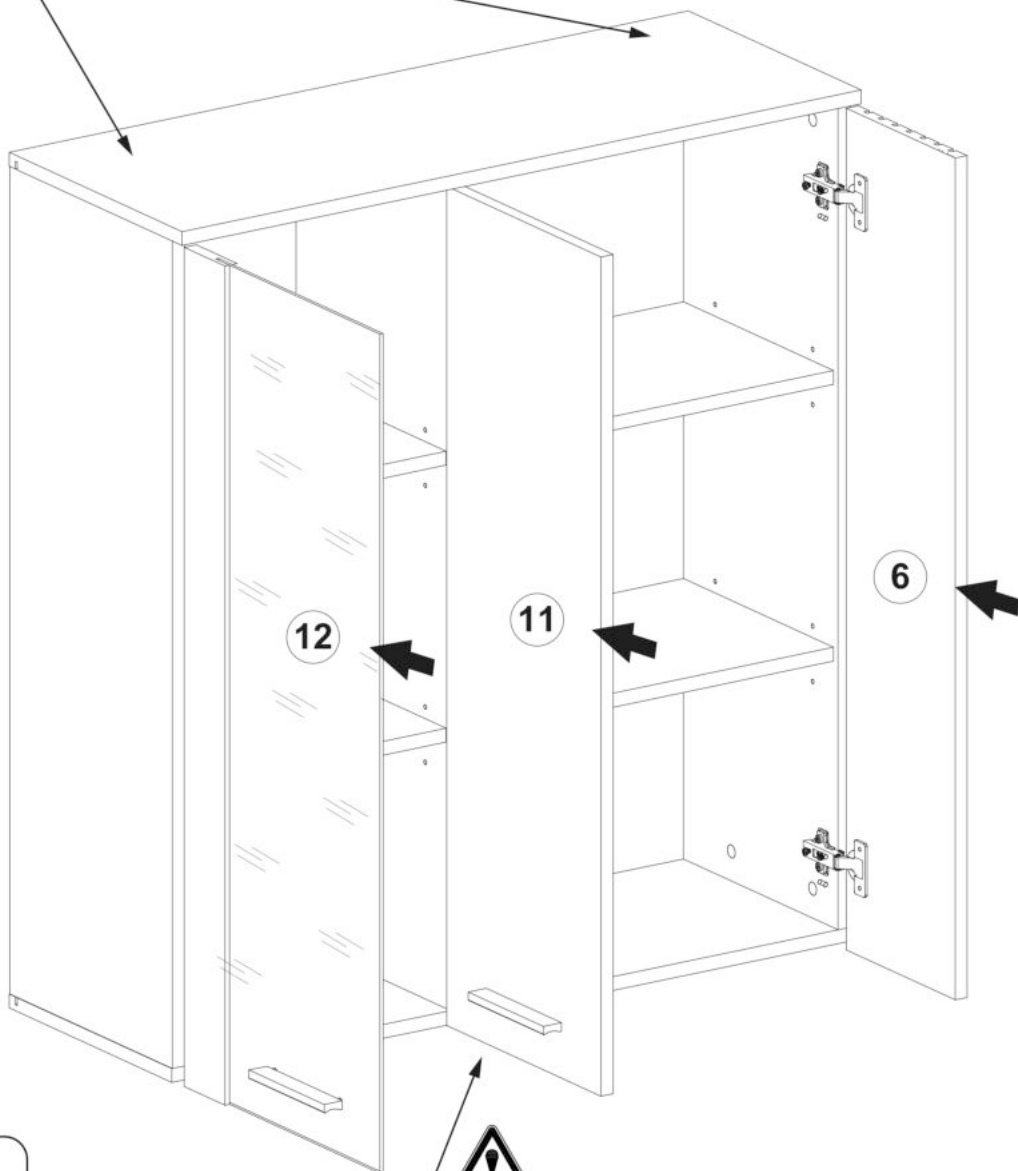
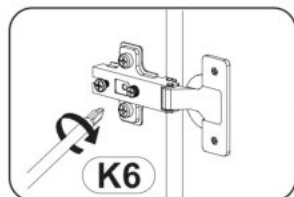
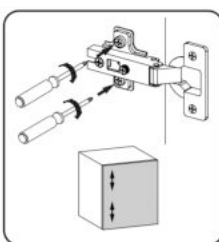
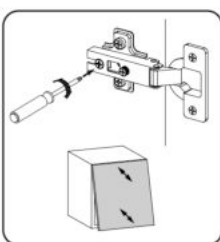
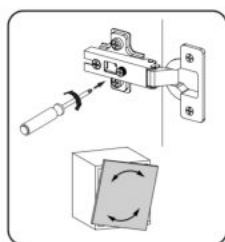
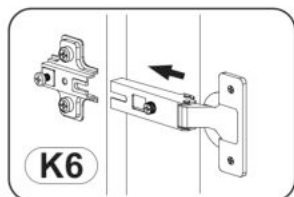

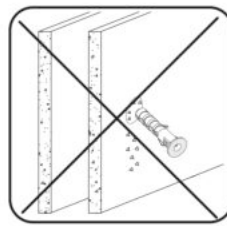
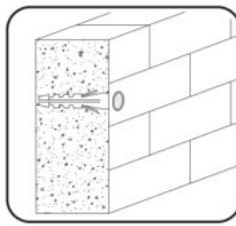

- Y40** 55mm x2
- Y39** 10x50 x2

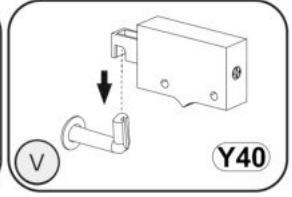
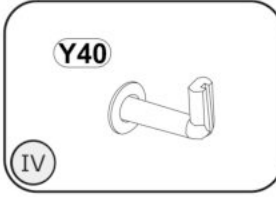
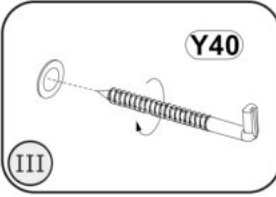
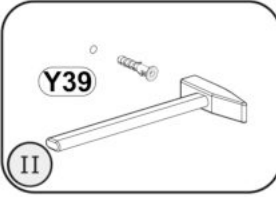
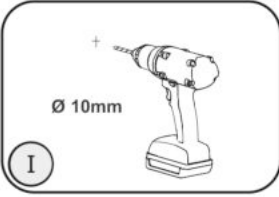

847mm

